

mira

Elite **ST**



PUMPED ELECTRIC SHOWER

Installation and User Guide

THESE INSTRUCTIONS ARE TO BE LEFT WITH THE USER
Uploaded on <http://www.qssupplies.co.uk> - Document BY MIRA

Contents

Introduction.....	3
Important Safety Information	4
Pack Contents Checklist	6
1. Mira Elite ST.....	6
2. Documentation	6
3. Mira Logic Electric Shower Fittings	7
Specifications	8
1. Plumbing	8
2. Electrical.....	8
3. Standards and Approvals	8
Installation Requirements.....	9
1. Plumbing	9
2.1 Electrical.....	13
2.2 Electrical (checklist in detail)	14
Installation	15
Mira Elite ST.....	15
Mira Logic Electric Shower Fittings	17
Commissioning.....	19
User Instructions	21
Using Your Shower.....	22
Fault Diagnosis.....	24
Maintenance.....	27
Handset - Cleaning.....	27
Filter - Cleaning/Renewing	27
Dimensions.....	28
Wiring Diagram.....	29
Spare Parts	30
Mira Elite ST Spare Parts List	30
Mira Logic Electric Shower Fittings Spare Parts List.....	32
Optional Accessories.....	33
Notes	34
Customer Service.....	Back Page

Introduction

Thank you for purchasing a quality Mira product. To exploit the full potential of your new product, please take time to read this guide thoroughly. Having done so, keep it handy for future reference.

The Mira Elite ST is a tank-fed (cistern-fed) pumped electric shower for use where the mains water supply pressure is too low, unreliable or non-existent, to operate a conventional electric shower.

The Mira Elite ST features an internal pump unit which has been designed to provide all year round performance, even at the highest flow rates which are necessary during the summer months. The Elite ST has separate controls for power selection and temperature/flow adjustment. The Elite ST **MUST** have its own separate cold water supply from the cistern to ensure correct operation.

The Mira Elite ST comes complete with a set of Mira Logic Electric Shower Fittings.

Products Covered By This Guide:

Mira Elite ST - A 9.8 kW @ 240 Volts AC (9.0 kW @ 230 Volts AC) heater. Available in white/chrome finish.

Mira Logic Electric Shower Fittings

An adjustable spray handset with four different spray actions (start, soothe, force and eco), supplied complete with flexible hose, clamp bracket assembly, slide bar, supports, soap dish/hose retaining ring. Available in white/chrome finish.

If you experience any difficulty with the installation or operation of your new shower control, then please refer to "**Fault Diagnosis**", before contacting Kohler Mira Limited. Our telephone and fax numbers can be found on the back cover of this guide.

Important Safety Information

1. Warning!

1.1 Products manufactured by us are safe and without risk provided they are installed, used and maintained in good working order in accordance with our instructions and recommendations.

1.2 THIS APPLIANCE MUST BE EARTHED. MAKE SURE SUPPLEMENTARY BONDING COMPLIES WITH THE "REQUIREMENTS FOR ELECTRICAL INSTALLATIONS".

In accordance with the current edition of BS 7671 'The IEE Wiring Regulations' in force at the time of installation. This appliance is intended to be permanently connected to the fixed electrical wiring of the mains system with its own dedicated supply.

1.3 DO NOT twist the individual cable cores of the live and neutral conductors, as this will prevent them from entering the terminal block.

1.4 The shower unit must **NOT** be fitted where it may be exposed to freezing conditions. Make sure that any pipework that could become frozen is properly insulated.

1.5 DO NOT operate this appliance if it appears to be frozen. Allow the appliance to thaw and then contact your installer before using again.

1.6 There are no user serviceable components beneath the cover of this appliance. Only a competent tradesperson should remove the cover. If the cover is removed, the following warnings must be observed:

1.6.1 Turn off the electrical and water supplies before removing the cover.

1.6.2 Mains connections are exposed when the cover is removed.

1.6.3 Refer to the wiring diagram before making any electrical connections (see section "Wiring Diagram").

1.6.4 Make sure all electrical connections are tight, to prevent them overheating.

1.7 If any of the following conditions occur, isolate the electricity and water supplies. Contact your installer or refer to "**To contact us**", on the back page of this guide:

1.7.1 If water is leaking from inside the product.

1.7.2 If the case is damaged.

1.7.3 If the appliance begins to make an odd noise, smell or smoke.

1.7.4 If the appliance shows signs of a distinct change in performance, indicating a need for maintenance.

1.7.5 If the cover is not correctly fitted.

1.8 DO NOT fit any form of outlet flow control as the outlet acts as a vent for the tank body. Only Mira recommended outlet fittings should be used.

2. Caution!

- 2.1** Read all of these instructions and retain this guide for later use.
- 2.2** Pass on this guide in the event of change of ownership of the installation site.
- 2.3** Follow all warnings, cautions and instructions contained in this guide, and on or inside the appliance.
- 2.4** The electrical installation must comply with the “Requirements for Electrical Installations” (see section "Installation Requirements") commonly referred to as BS 7671 the IEE Wiring Regulations, or any particular regulations and practices, specified by the local electricity supply company in force at the time of installation. The installation should be carried out by an electrician or contractor who is registered, or is a member of, an association such as:
 - 2.4.1** National Inspection Council for Electrical Installation and Contracting (NICEIC), throughout the UK.
 - 2.4.2** The Electrical Contractors Association (ECA), England and Wales.
 - 2.4.3** The Electrical Contractors Association of Scotland (ECAS).
- 2.5** The plumbing installation must comply with the requirements of UK Water Regulations/Bye-laws (Scotland), Building Regulations or any particular regulations and practices, specified by the local water company. The installation should be carried out by a plumber or contractor who is registered, or is a member of, an association such as:
 - 2.5.1** Institute of Plumbing (IOP), throughout the UK.
 - 2.5.2** National Association of Plumbing, Heating and Mechanical Services Contractors (NAPH & MSC), England and Wales.
 - 2.5.3** Scottish and Northern Ireland Plumbing Employers' Federation (SNIPEF), Scotland and Northern Ireland.
- 2.6** Anyone who may have difficulty understanding or operating the controls of any shower should be attended whilst showering. Particular consideration should be given to the young, the elderly, the infirm, or anyone inexperienced in the correct operation of the controls.
- 2.7** When this appliance has reached the end of its serviceable life, it should be disposed of in a safe manner, in accordance with current local authority recycling, or waste disposal policy.

Pack Contents Checklist

☑ Tick the appropriate boxes to familiarize yourself with the part names and to confirm that the parts are included.

1. Mira Elite ST

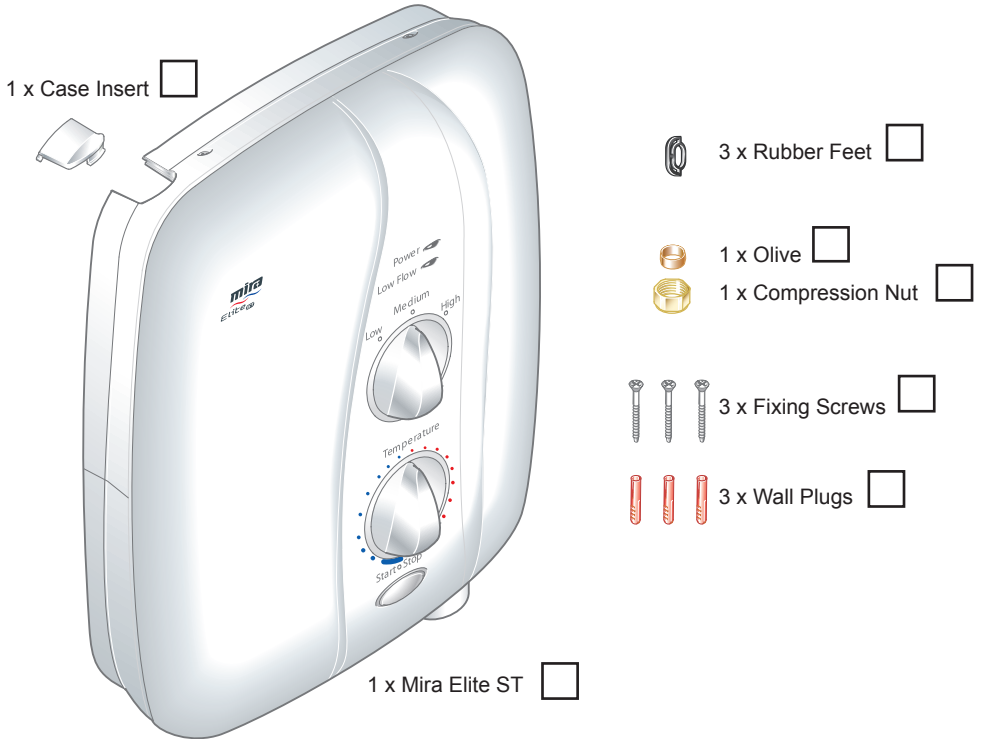

2. Mira Logic Electric Shower Fittings

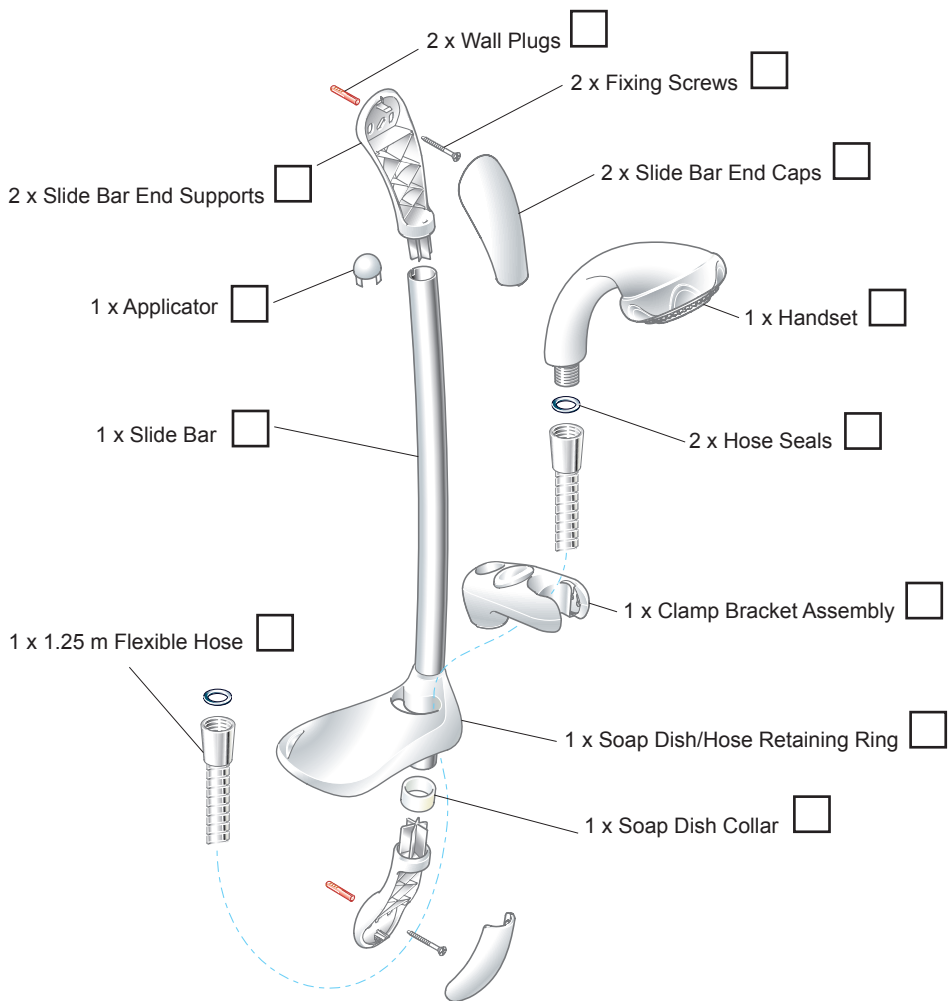

3. Documentation

- 1 x Installation and User Guide
- 1 x Installer Checklist
- 1 x Guarantee Card
- 1 x Template (Use inner fitment)

Specifications

1. Plumbing

- 1.1 The 15 mm inlet compression connector incorporates an inlet filter. The inlet swivels to allow top, bottom or rear entry.
- 1.2 The outlet terminates with a 1/2" BSP male thread for connection to a Mira flexible shower hose.

2. Electrical

This is a high power unit, it is essential to contact your electricity supply company to make sure that the electricity supply is adequate for the purpose.

- 2.1 The terminal block will not accept cable larger than 16 mm².
- 2.2 The motor is fitted with a self resetting thermal trip protection device, designed to operate if the ambient temperatures become too high. The maximum recommended ambient temperature for the Elite ST is 30°C.
- 2.3 The following power ratings for the heater tanks are available with their respective voltages: Mira Elite ST 9.8 kW @ 240 V / 45 Amps (9.0 kW @ 230 V / 40 Amps).
- 2.4 The motor will absorb approximately 100 Watts maximum power under normal working conditions.

3. Standards and Approvals

- 3.1 The Mira Elite ST has been designed to comply with the requirements of the British Electrotechnical Approvals Board (BEAB) and the requirements of UK Water Regulations/Bye-laws (Scotland).
- 3.2 This Mira Elite ST complies with all relevant directives for CE marking.

Installation Requirements

1. Plumbing

Read the section 'Important Safety Information' first.

- 1.1** The Elite ST is designed to operate with water supply pressures from 0.8 kPa (0.008 bar / 80 millimetres head) to 100 kPa (1 bar / 10 metres head) (i.e. the vertical distance from the base of the cold cistern to the top of the Elite ST). However, the minimum head required will increase with pipe length and the guide given in paragraph 1.17 should be used to make sure that adequate head is available for any given installation.

The Elite ST **MUST** have its own separate supply from the cistern.

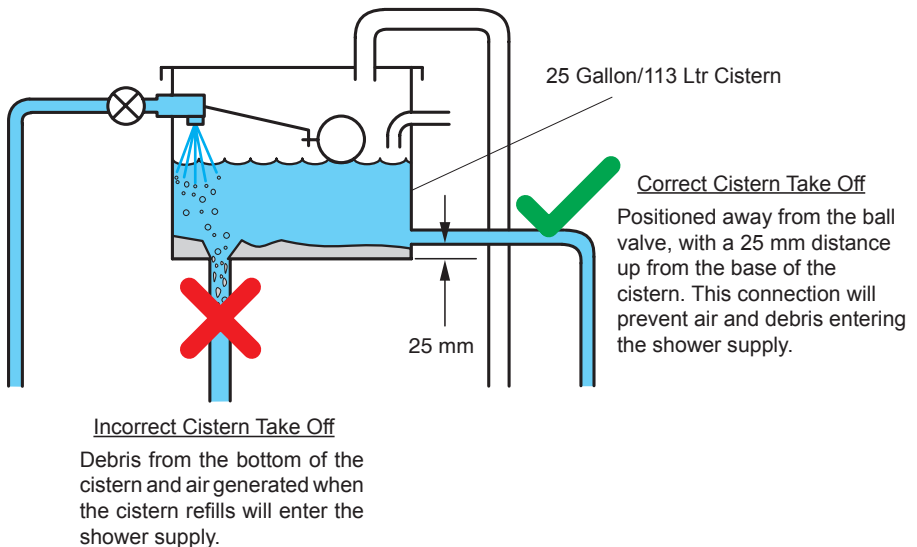

- 1.2** The Elite ST is suitable for installation within the shower area and is fitted with a pressure relief valve. It must be positioned over a water catchment area with the controls at a convenient height. The shower fitting should be positioned so that it discharges down the centre line of the bath, or across the opening of a shower cubicle, and must be directed away from the shower unit.
- 1.3** Use a minimum of 15 mm diameter supply pipework. It should be noted, however, that on long pipe runs this should be increased to 22 mm (refer to para 1.17 for guidance). When using flexible plastic pipe it is essential that the pipe is kept flat and not looped up at any point as this may lead to air build up which may impair performance of the shower.

- 1.4** A non restrictive (free flowing) isolating valve should be fitted into the supply from the cold water cistern, for maintenance purposes.
- 1.5** The Elite ST must be fitted ONTO the finished wall surface i.e. on top of the tiles. **DO NOT** block the air ventilation gaps around the sides of the unit, either by tiling up to the sides of the unit or by using a sealant around the case.
Important! This Elite ST is designed to be ventilated. Failure to do this may cause product failure.
Note! The Mira Elite ST is fitted with a pump motor, and some mechanical noise can be expected in addition to the noise generated by the spray from the handset. The type of wall surface will affect the perceived sound levels. Stud partition and panel walls have a tendency to resonate, whilst solid walls provide the quietest operation. The tone of the pump motor may change when the temperature control knob is adjusted. This is quite normal.
- 1.6** Inlet: 15 mm inlet compression connector is designed to accept plumbing supplies from the top, bottom or rear.
- 1.7** Rear entry plumbing is accommodated without the need to recess the 15 mm inlet compression connector, enabling the wall's surface to be completed and sealed to prevent water ingress, before final fitting.
- 1.8** Swivel the inlet connector assembly to suit (not directly back into the wall). Avoid trapping the green earth bonding wire.
- 1.9** Use only the 15 mm inlet compression connector supplied with the Elite ST, do not use any other types of fitting.
- 1.10** Outlet: 1/2" BSP male, to accept Mira flexible hose.
- 1.11** Refrain from applying excessive force when making connections.
Note! Excessive force on the pump housing can impair pumping performance. Make sure that the supply pipe is trimmed and bent such that the 15 mm inlet connector sits (or can be lightly pressed) easily on the back of the clamp bracket prior to connection with the pump housing.
- 1.12** To avoid damage to the case when soldered fittings are used, pre-solder the pipework and fittings before connecting them to the 15 mm inlet compression connector.
- 1.13** Supply pipework **MUST** be flushed to clear debris before connecting the Elite ST.

1.14A hose retaining ring is supplied to prevent the handset from dropping below the spillover level of the bath or shower, which could lead to contamination from back-siphonage (refer to illustration). The supplied hose retaining ring should meet the great majority of user requirements for shower installations with flexible outlet fittings. However, there will be occasions when the hose retaining ring will not provide a suitable solution. In these instances an **outlet** double checkvalve, e.g. the Mira DCV-H, **must** be fitted. The inclusion of the Mira DCV-H will increase the required supply pressure typically by 10 kPa (0.1 bar).

Double checkvalves, fitted in the inlet supply to the appliance, cause a pressure build-up, which could exceed the maximum static inlet pressure for the appliance.

1.15When installed in very hard water areas (above 200 ppm temporary hardness) your installer may advise the installation of a water treatment device, to reduce the effects of limescale formation. Your local water company will be able to advise the hardness of water in your area.

1.16Avoid layouts where the hose will be sharply kinked. This may reduce the life of the hose.

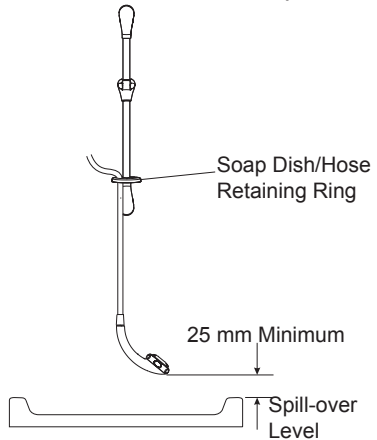

1.17Long pipe runs and excessive use of 90° elbows will significantly reduce the available head to supply the Elite ST. The pipework table should be completed to ensure that adequate head is available for any given application.

Pipework

The dimension (x) is calculated from the table below to give you a minimum effective head of 80 mm which is necessary to produce a satisfactory shower in all conditions.

Plumbing Schematic Diagram

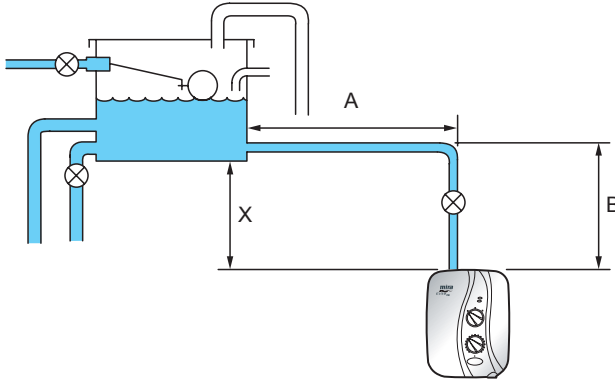

Example! The example below is based on the diagram above with 15 mm pipework, A = 1.5 m, B = 0.75 m.

Size	Quantity	Head Loss (mm)
15 mm Pipe	(A) <u>1.5</u> + (B) <u>0.75</u> = <u>2.25</u> x 120	270
22 mm Pipe	(A) _____ + (B) _____ = _____ x 20	
15 mm Elbow	Number of Elbows <u>1</u> x 55	55
22 mm Elbow	Number of Elbows _____ x 15	
	Minimum Effective Head	80
	(x) mm	405

2.1 Electrical

Read the section 'Important Safety Information' first.

Checklist

2.1.1 Electrical supply fuse and consumer unit are adequate for the product.

2.1.2 Shower unit is earthed.

2.1.3 The minimum required supply cable size must conform to BS 7671.

2.1.4 Double pole isolating switch.

2.1.5 Do not twist live or neutral cable cores.

2.1.6 Electrical connections are tightly secured.

Do not strain terminal block.

2.1.7 Plumbing supply completed before electrical supply is turned on.

Plumbing and Electrical Schematic Diagram

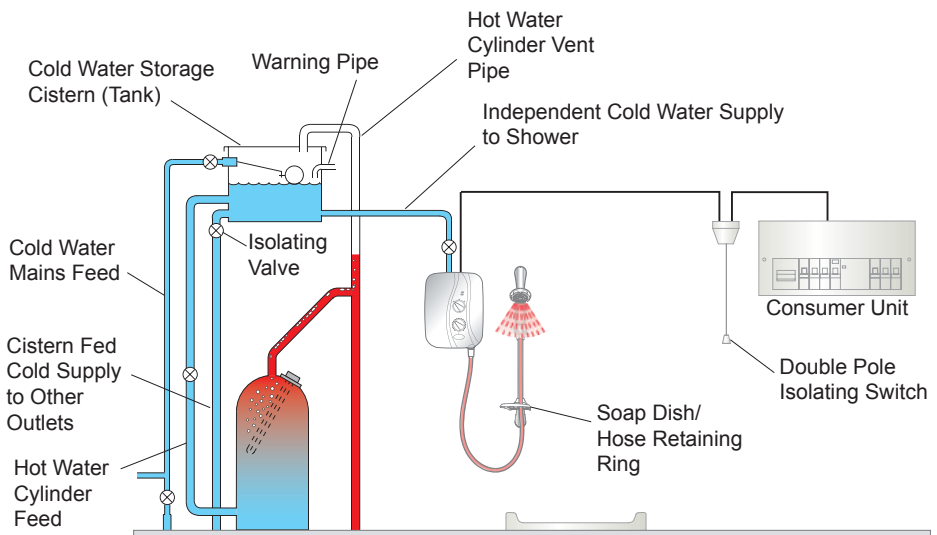

2.2 Electrical (checklist in detail)

2.2.1 In a domestic installation, the rating of the electricity supplier's fuse and the consumer unit must be adequate for the additional demand. The Mira Elite ST is a high power unit, therefore it is essential to contact your electricity supplier to ensure that the supply is adequate for the product. Voltage drop due to local heavy demand will reduce the shower's performance.

2.2.2 The Mira Elite ST **must be earthed** by connecting the supply-cable earth conductor to the earth terminal.

Supplementary bonding: Within the bathroom or shower room, all accessible conductive parts of electrical equipment and extraneous conductive parts (metal parts) that are likely to introduce earth potential, must be electrically bonded to earth using a minimum cable size of 4.0 mm² if the cable is not mechanically protected, (2.5 mm² if mechanically protected).

2.2.3 Supply cable - refer to: '**Electrical Checklist**'.

2.2.4 **As a guide only**, and in accordance with BS 7671 we recommend close circuit protection:

i.e. 9.8 kW @ 240 V = 45 Amp (9.0 kW @ 230 V = 40 Amp).

It is strongly recommended that a 30 mA Residual Current Device (RCD) is included in the electrical circuit. This may be part of the consumer unit or a separate unit.

A separate, permanently connected supply is taken from the consumer unit to the appliance through a double-pole switch, which has at least 3 mm contact separation. The switch can be a ceiling mounted pullcord type within the shower room or a wall mounted switch in an adjacent room.

2.2.5 **DO NOT** twist the individual cable cores of either the live or neutral conductors, as this will prevent them from entering the terminal block.

2.2.6 **DO NOT** exert strain on the terminal block. Ensure that the electrical connections are tightly screwed down.

2.2.7 **DO NOT** turn on the electrical supply until the plumbing has been completed.

Installation

Mira Elite ST

Read the section 'Important Safety Information' first.

1.



Electrical supply is turned off at the mains.

2.

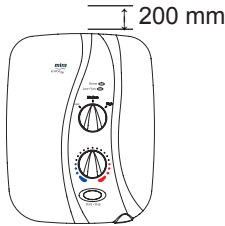

200 mm minimum gap from ceiling.

3.



Remove the four cover screws.

4.

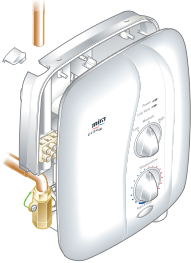

Remove the cover and determine supply pipe position.

5.

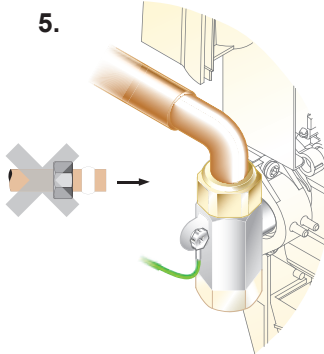

For rear inlet, use soldered elbow.
Do not trap green wire.

6.

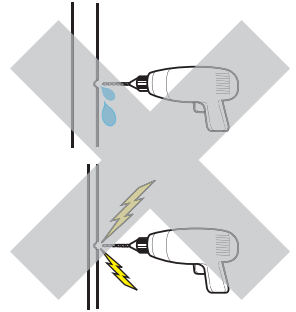

CAUTION! Do not drill into buried cables or pipes.

7.

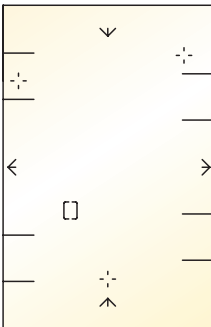

Drill and plug* the three holes using the template.

8.

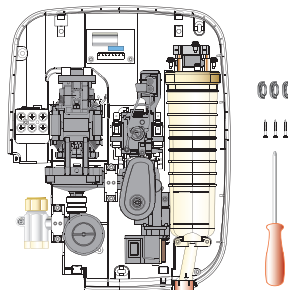

Fit Rubber Feet and fix appliance to wall.

9.



Flush a minimum of 10 litres through pipework.

* Alternative fixings for some wall structures are not supplied.

10.

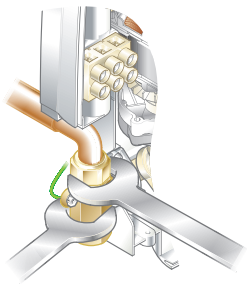

Connect supply pipe. **Do not overtighten!**

11.



Feed cable into Case. Fit Earth sleeve (not supplied) and strip insulation.

Do not twist cable cores.

12.

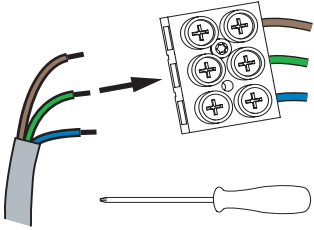

L = BROWN
E = GREEN
N = BLUE

Firmly connect the conductors. **Do not exert strain on the terminal block.**

13.

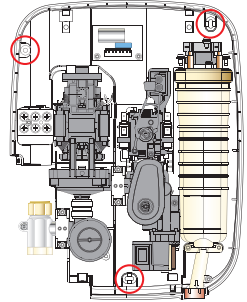

Make sure wires are clear of all mounting holes.

14.



Refit the Service Tunnel and Cover. Make sure they fit correctly.

Do not overtighten screws.

15.

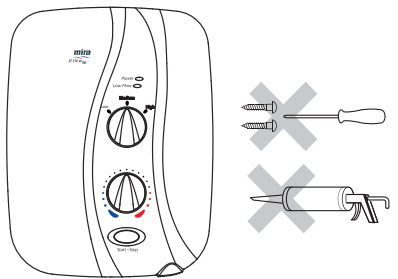

Do not use alternative screws to secure the Cover. This can cause internal damage to the appliance.

Do not seal around the back of appliance.

Mira Logic Electric Shower Fittings

Read the section 'Important Safety Information' first.

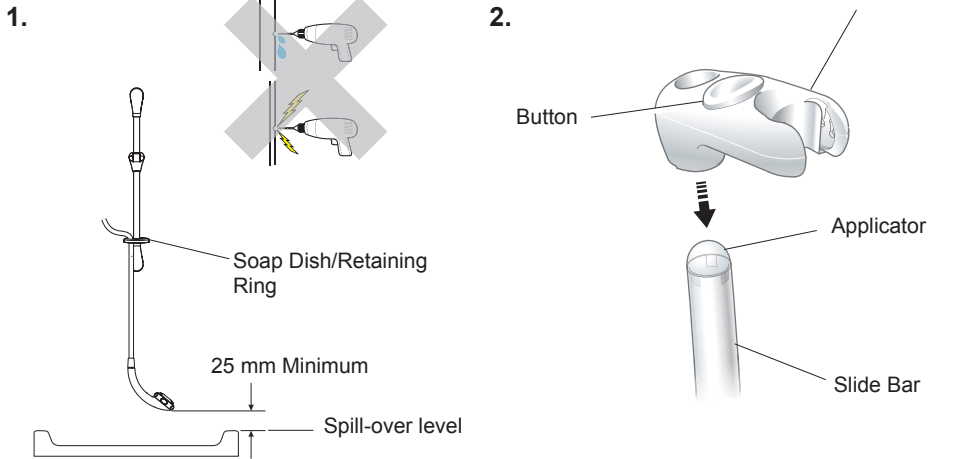

Position as shown to prevent back siphonage.

Depress button **FULLY** and assemble Clamp Bracket. Release button and remove Applicator.

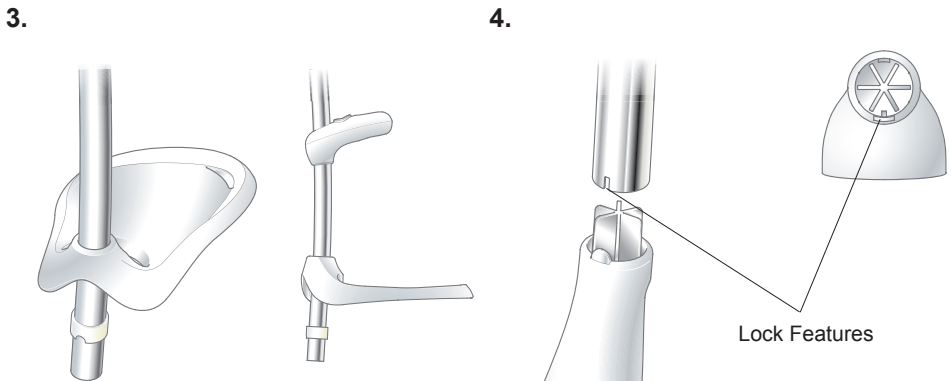

Slide the Soap Dish/Hose Retaining Ring and the Soap Dish Support collar onto the Slide Bar below the Clamp Bracket.

Fit both the top and bottom Supports. Make sure the slots are aligned to fit fully home.

5.

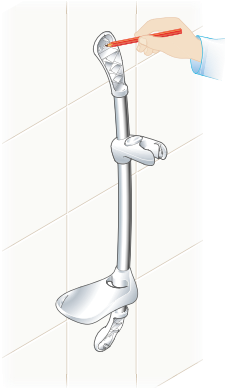

Mark the position of the middle slot on both top and bottom Supports.

6.

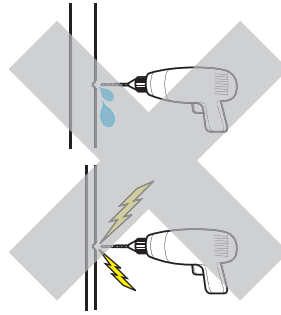

CAUTION! Do not drill into buried cables or pipes.

7.

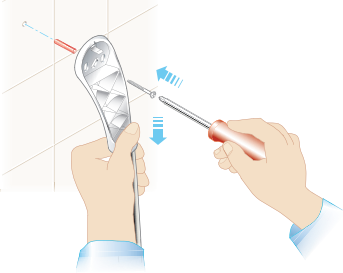

First fix the bottom Slide Bar Support and fully tighten the screw*. Then fix the top Slide Bar support whilst pressing it down, to keep the whole assembly together.

8.

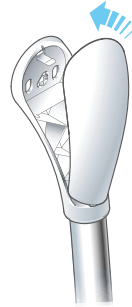

Fit the End Caps to the Slide Bar supports.

9.

Fit the Hose to both the Handset and the Shower Outlet, remembering to pass it through the Soap Dish/Hose Retaining Ring. Do not overtighten the Hose connections.

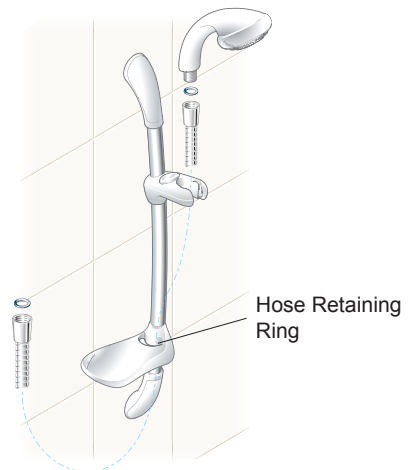

* Alternative fixings for some wall structures are not supplied.

Commissioning

If you are unsure how electric showers work, please read through the 'User Instructions' Section before continuing.

- 

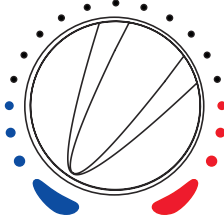
Electrical supply is turned off at the mains.
- 

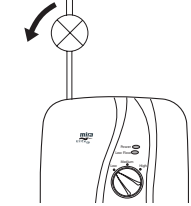
Turn **BOTTOM** control to full cold.
- 

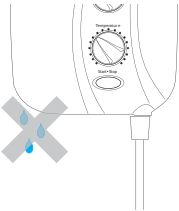
Turn water supply fully on.
- 

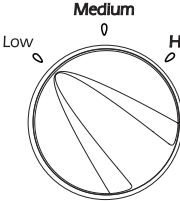
Check for water leaks.
- 

Turn **TOP** control to **LOW**.
- 

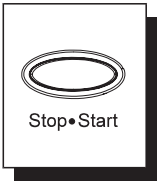
Switch on electrical supply.
- 

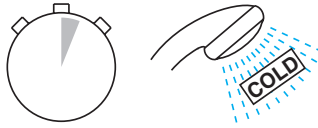
Push **START** button.
- 

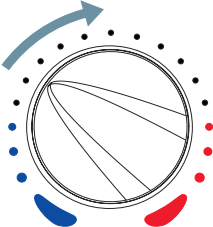
Water will be at full force and at a cool temperature.
- 

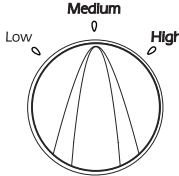
Turn **BOTTOM** control slowly. Temperature remains cool and flow is reduced.
- 

Set the **TOP** control to **MEDIUM**.
- 

The temperature will rise slightly.

13.

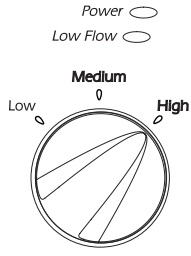

Set the TOP control to HIGH.

14.



0-5 secs

The temperature will rise further.

15.

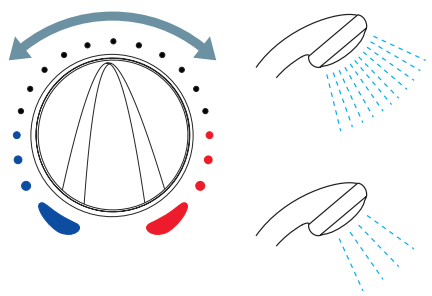

Adjust temperature as required.
Flow rate will adjust automatically.

16.

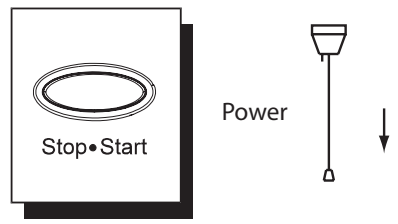

Press STOP and isolate power.

17.

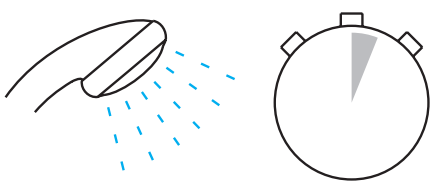

0-5 secs

The shower will purge water from
its tank for a few seconds.

18.

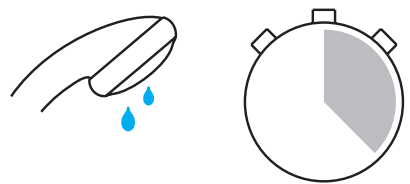

Residual water may drain over
a few minutes.

User Instructions

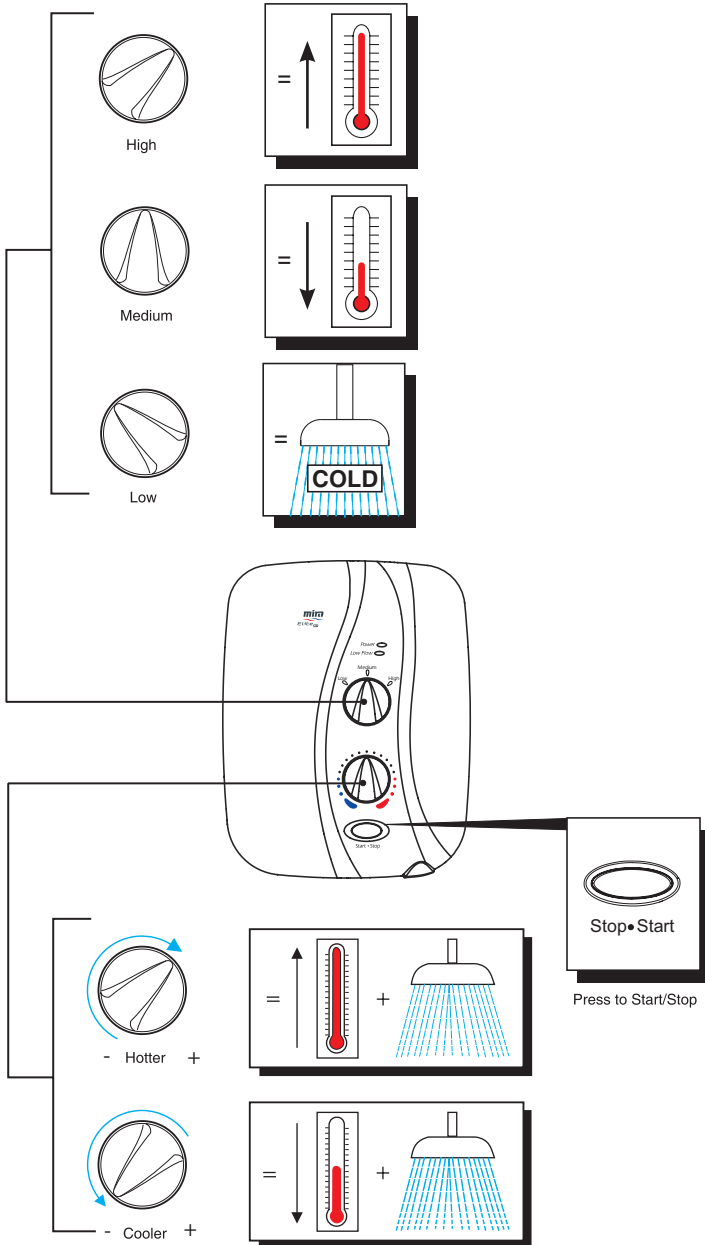

Operation of the Mira Elite ST

Using Your Shower

Read the section 'Important Safety Information' first.

1.



Switch on electrical supply.

2.

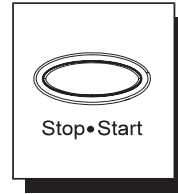

Press START button.

3.

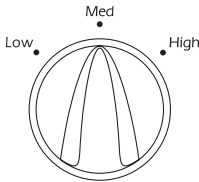

Set to desired position.

4.

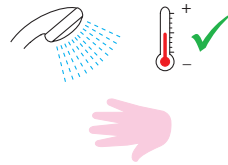

Check water temperature before entering shower.

5.

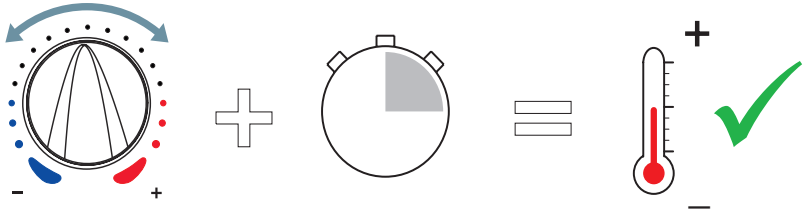

Allow 10-15 seconds for any temperature adjustments to reach the handset.

6.

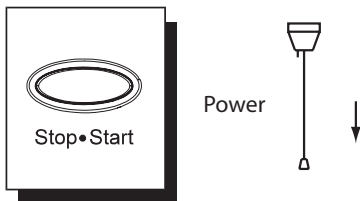

Press STOP button. Shower will continue to run for a few seconds before stopping.

7.

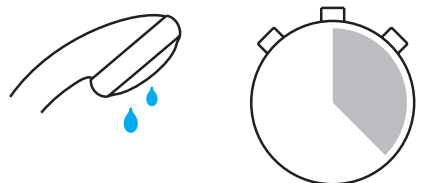

A small amount of water may continue to drain over a few minutes.

Changing the Spray Setting

The handset has four different spray settings (Eco, Start, Soothe and Force).

1.

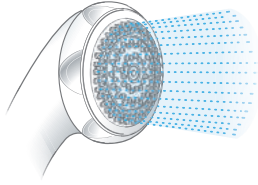

Eco

Turn the Spray Plate fully clockwise. A reduced flow of water will flow from the outer set of holes.

2.

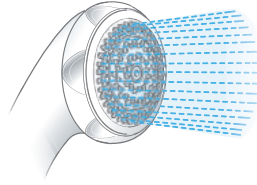

Start

Turn the Spray Plate anticlockwise until it 'clicks'. Water will flow from the outer set of holes.

3.

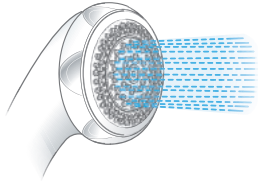

Soothe

Turn the Spray Plate anticlockwise until it 'clicks'. Water will flow from the middle set of holes.

4.

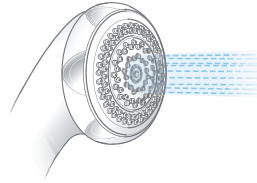

Force

Turn the Spray Plate anticlockwise until it 'clicks'. Water will flow from the inner set of holes.

Adjusting the Clamp Bracket

1.

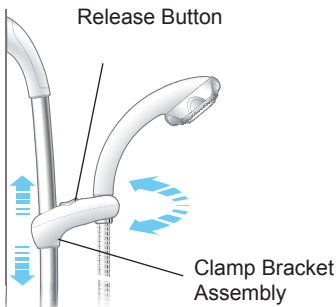

Depress the release button and slide the Clamp Bracket assembly to the required position.

2.



Move the handset to the required angle.

Fault Diagnosis

The trouble shooting information below gives details on probable causes and remedies should difficulties be encountered whilst the shower is in operation.

Warning! There are no user serviceable components beneath the cover of the appliance.

ONLY A COMPETENT TRADESPERSON SHOULD REMOVE THE FRONT COVER!

Symptom	Power Light	Low Flow Light	Heater Setting Low / Medium / High	Probable Cause	Possible Remedy
<i>Elite ST fails to operate.</i>	OFF	OFF	Any	Electrical supply isolated at double pole switch.	Switch on electrical supply via pullcord or wall mounted switch.
	OFF	OFF	Any	Fuse blown or MCB/RCD tripped indicating possible electrical fault.	Renew the fuse or reset the MCB/RCD. If fault persists, contact your installer.
<i>No water or very low flow rate.</i>	ON	ON	Any	Hose or handset sprayplate blocked.	Remove and clean.
	ON	ON	Any	Incoming water supply isolating valve turned down or off.	Turn isolating valve to fully on position.
<i>Shower cycles from hot to cold.</i>	ON	OFF	Medium / High	Temperature knob or heater setting too high.	Turn the TOP knob to MEDIUM setting and re-adjust temperature knob until suitable temperature is achieved.
	ON	ON	Medium / High	Handset sprayplate blocked.	Remove and clean.
<i>Unable to select a cool enough temperature.</i>	ON	OFF	High	Due to a rise in the stored water temperature, the power rating may be too high.	Turn the TOP knob to MEDIUM setting and re-adjust temperature knob until suitable temperature is achieved.

Symptom	Power Light	Low Flow Light	Heater Setting Low / Medium / High	Probable Cause	Possible Remedy
	ON	ON	Medium / High	Handset sprayplate blocked.	Remove Handset and clean.
<i>No water and motor tone increases.</i>	ON	ON	Any	Cistern has run out of water.	Turn off the Elite ST immediately and resolve cistern storage difficulty.
	ON	ON	Any	Internal pump unit faulty or thermal trip has operated.	Wait for internal pump / shower to cool down. If still faulty contact your installer.
ALL OF THE FOLLOWING REMEDIES MUST ONLY BE PERFORMED BY A COMPETENT TRADESPERSON!					
<i>Handset dripping.</i>	OFF	OFF	Any	Flow Valve faulty.	Replace.
<i>Low or no flow.</i>	ON	ON	Any	Filter or water supply pipework restricted by a blockage or partial blockage.	Flush supply pipe. Clean filter.
	ON	ON	Any	Insufficient water supply pressure / flow for operation.	Gravity fed system, minimum pressure 0.8 kPa (0.008 Bar / 80 mm).
	ON	OFF	Any	Hose or handset sprayplate blocked.	Remove and clean.
	ON ON	OFF OFF	Any Any	Flow Valve faulty. Heater tank excessively scaled.	Replace. Replace. In hard water areas consider the use of a water softener.
(Continued . . .)					

Symptom	Power Light	Low Flow Light	Heater Setting Low / Medium / High	Probable Cause	Possible Remedy
	ON	OFF	Any	Service tunnel or cover not fitted correctly causing Start/Stop button not to operate.	Check case inserts are cut and fitted correctly. Check services (electrical / plumbing) are not interfering with the location of service tunnel or cover.
	ON	OFF	Any	Pump faulty.	Replace.
<i>Operation of Temperature Control has little or no effect on water temperature.</i>	ON	ON	Medium / High	Hose, handset or Filter blocked.	Remove and clean.
	ON	OFF	Medium / High	Flow Valve faulty.	Replace.
	ON	OFF	Medium / High	Heater Tank failure.	Replace.
	ON	OFF	Medium / High	Microswitch failure.	Replace.
<i>No change in temperature between Low / Medium/ High settings.</i>	ON	OFF	Any	Possible Flow Valve, Microswitch or Heater Tank failure.	Use a suitable continuity device to check the continuity of the Microswitch or Heater Tank and replace parts as required.
<i>Water will not turn off.</i>	ON	OFF	Medium / High	Flow Valve, Solenoid or Start/Stop switch faulty.	Replace parts as required.
<i>Appliance fails to produce hot water when set on Medium / High heater setting.</i>	ON	OFF	Medium / High	Possible Microswitch or Thermal Switch failure.	Use a suitable continuity device to check the continuity of the Microswitch or Heater Tank and replace parts as required.
	ON	OFF	Medium / High	Possible Heater Tank failure.	Replace.

Maintenance

Handset - Cleaning

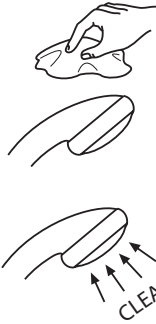

Clean with mild washing up detergent or soap solution. Wipe dry with soft cloth.

Poor shower performance can be avoided by descaling the spray head, which must be done regularly. Use thumb or soft cloth to wipe rubber nozzles.

Filter - Cleaning/Renewing

Read the section 'Important Safety Information' first.

1.



Electrical supply is turned off at the mains.

2.

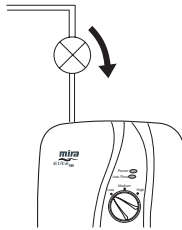

Turn water supply fully off.

3.



Remove the four screws and the Cover.

4.

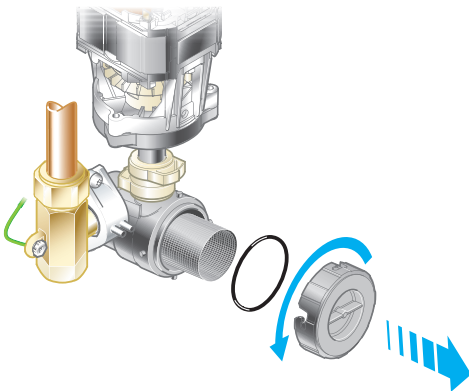

Press down on the filter cover and turn anti-clockwise to release.

Remove the filter cover and filter.

Clean the filter and wipe the inside of the filter housing to remove any debris.

Replace the filter ensuring it is located over the pins in the filter body.

Refit in reverse order, making sure that the O-ring is correctly seated.

Dimensions

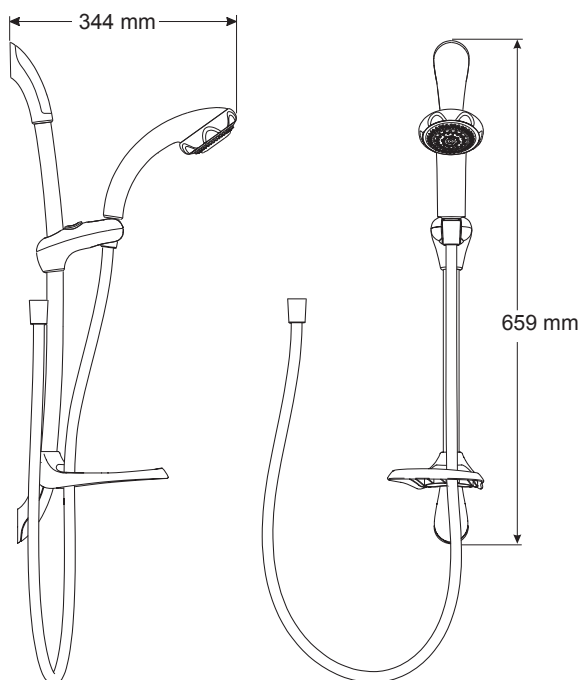
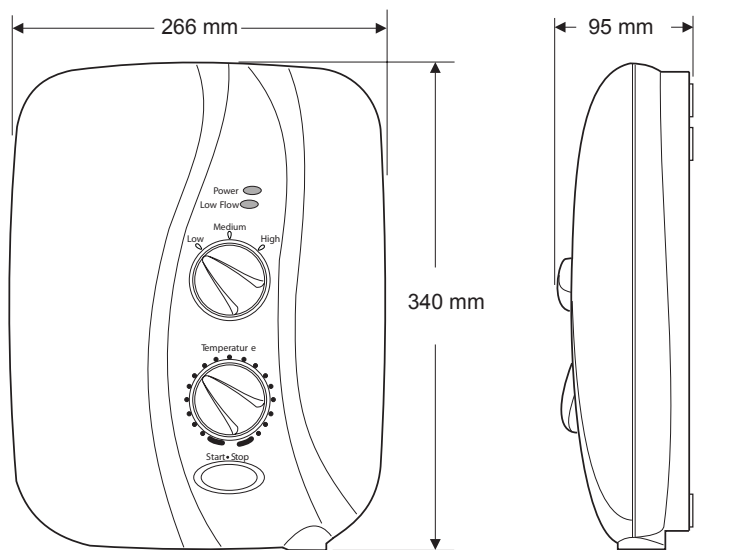

Wiring Diagram

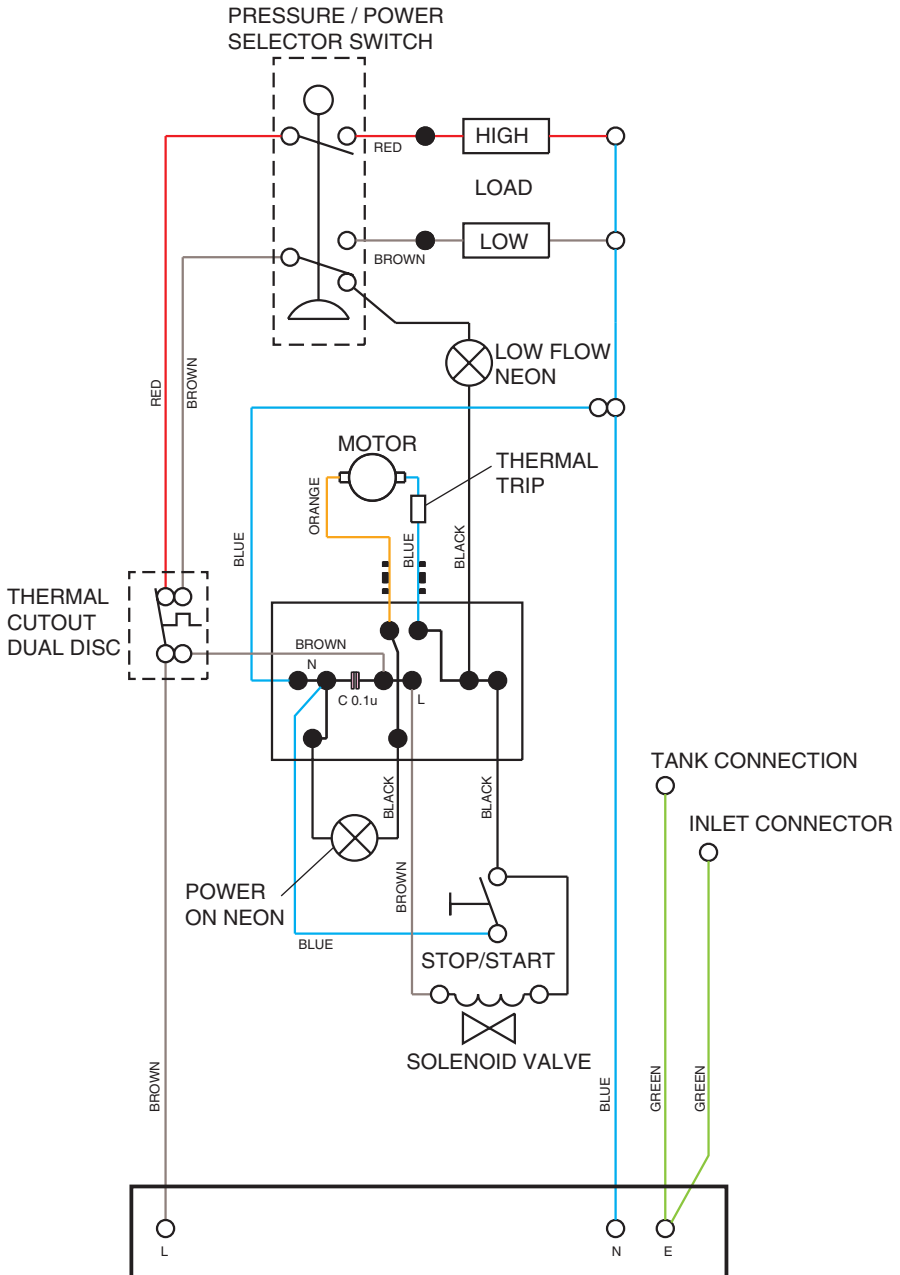

Spare Parts

Mira Elite ST Spare Parts List

215 12	Thermal Trip Pack
416 38	Clamp Bracket
416 41	Thermal Switch
416 43	Splash Guard
416 48	Latching Switch
416 51	Solenoid Coil Assembly
428 56	Cover Seal (not shown)
428 59	Service Tunnel
428 61	Transfer/Inlet Tubes
428 62	Motor/Pump Assembly
428 64	Motor Dust Shield
872 01	Microswitch N/O - 2 pin
872 28	Microswitch C/O - 3 pin
1563 516	Outlet Connector
1563 504	Heater Tank 9.8 kW
1563 507	Flow Valve Assembly
1563 509	Switch Assembly
1563 604	Cover Assembly
1563 605	Component Pack - components identified 'A'
1563 606	Terminal Block Assembly
1563 607	Wire Harness Assembly
1563 608	Screw Pack - components identified 'B'
1563 679	Filter Assembly Spare
1563 687	Filter Tube and Seal Pack - components identified 'C'
1563 691	Filter

Important Note!

Push-fit connectors must be assembled **back to back** onto the micro-switch terminals.

A minimum air gap of **4 mm** must be maintained between the connectors after assembly.

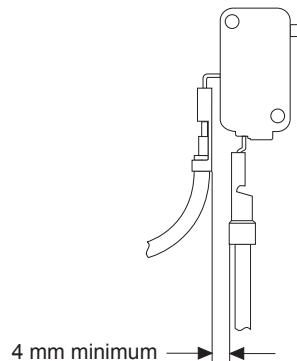

Mira Elite ST Spare Parts Diagram

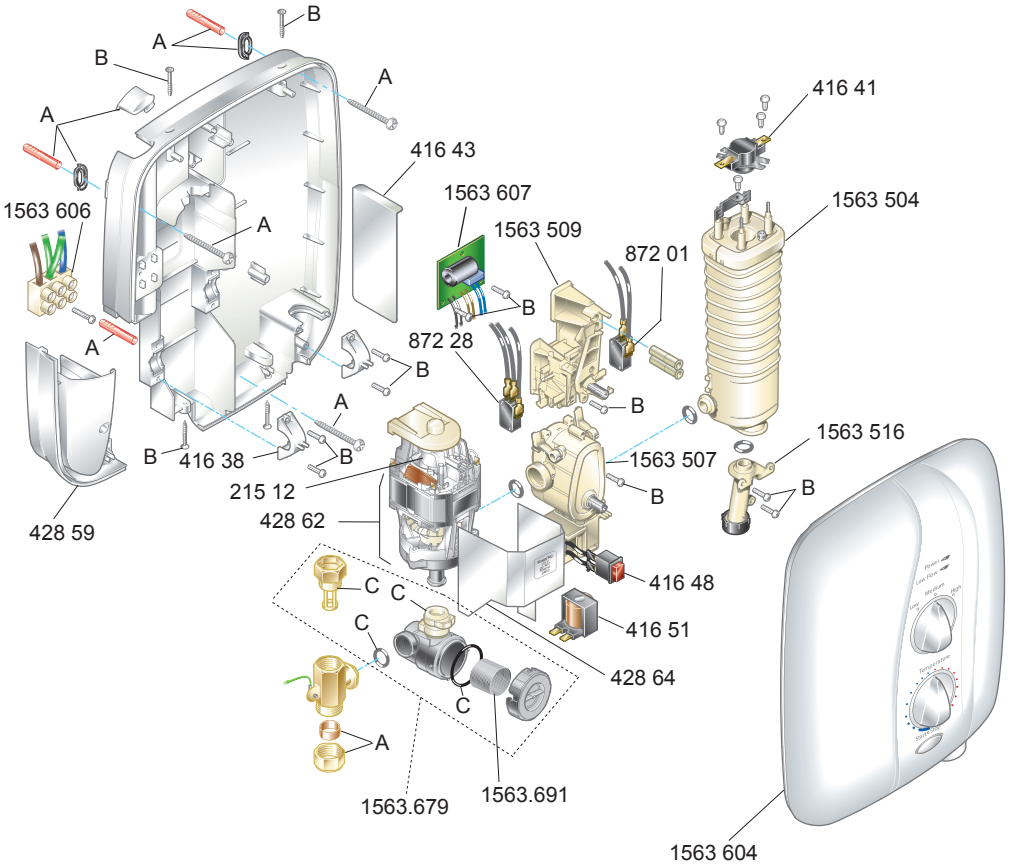

Mira Logic Electric Shower Fittings Spare Parts List

450.01	Hose 1.25 m - chrome
450.03	Adjuster Ring
450.06	Clamp Bracket Assembly - white
450.08	Service Pack 'O' seals - components identified 'A'
450.17	Slide Bar Wall Fixing Pack - components identified 'B'
450.26	Slide Bar Support Assembly - white - components identified 'D'
450.28	Slide Bar - chrome
450.36	LC Spray Plate Pack - white
632.73	Hose Washer
1563.257	Adjustable Handset Assembly
1563.552	Soap Dish/Hose Retaining Ring

Mira Logic Electric Shower Fittings Spare Parts Diagram

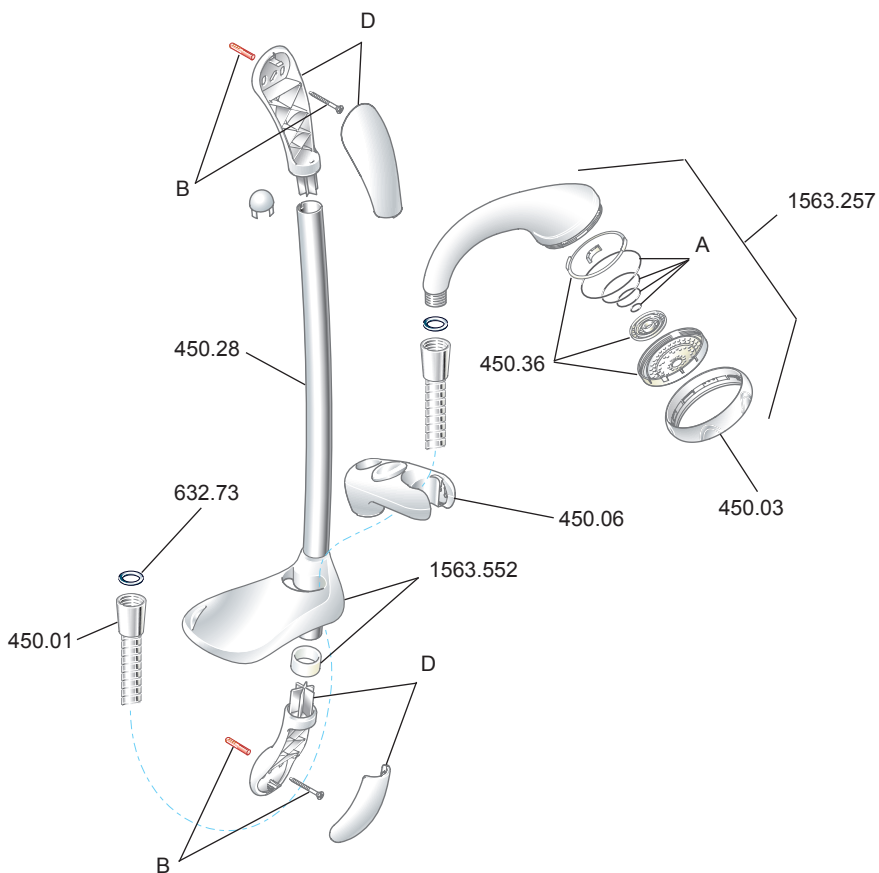

Optional Accessories

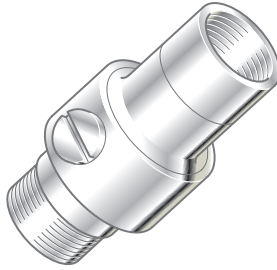

DCV-H: An outlet double check valve, designed to prevent the backflow or back-siphonage of potentially contaminated water, through shower controls which are fitted with a flexible hose as part of the outlet shower fitting. Available as an optional accessory from your Kohler Mira stockists.

Notes

Notes

Customer Service

Guarantee of Quality

Mira Showers guarantee your product against any defect in materials or workmanship for the period shown in the Guarantee Registration Document included with your shower.

Alternatively, to confirm the applicable guarantee period please contact Customer Services.

To validate the guarantee, please return your completed registration card.

Within the guarantee period we will resolve defects, free of charge, by repairing or replacing parts or modules as we may choose.

To be free of charge, service work must only be undertaken by Mira Showers or our approved agents in Northern Ireland and Republic of Ireland.

Service under this guarantee does not affect the expiry date.

The guarantee on any exchanged parts or product ends when the normal product guarantee period expires.

Not covered by this guarantee:

Damage or defects arising from incorrect installation, improper use or lack of maintenance, including build-up of limescale.

Damage or defects if the product is taken apart, repaired or modified by any person not authorised by Mira Showers or our approved agents.

This guarantee is in addition to your statutory and other legal rights.

Before using your shower

Please take the time to read and understand the operating and safety instructions detailed in this manual.

What to do if something goes wrong

If when you first use your shower it doesn't function correctly, first contact your installer to check that installation and commissioning are satisfactory and in accordance with the instructions in this manual. We are on hand to offer you or your installer any advice you may need.

Should this not resolve the difficulty, simply contact our Customer Services who will give every assistance, and if necessary arrange for our service engineer to visit.

If later the performance of your shower declines, consult this manual to see whether simple home maintenance is required. Please call our Customer Services to talk the difficulty through, request service under guarantee if applicable, or take advantage of our comprehensive After-Sales service.

As part of our quality and training programme calls may be recorded or monitored.

Our Customer Services Team is comprehensively trained to provide every assistance you may need: help and advice, spare parts or a service visit.

Spare Parts

We maintain an extensive stock of spares, and aim to have functional parts available for ten years from the date of final manufacture of the product.

Spares can be purchased from approved stockists or merchants (locations on request) or direct from Customer Services.

Spares direct will normally be despatched within two working days. Payment can be made by Visa or MasterCard at the time of ordering. Should payment by cheque be preferred a pro-forma invoice will be sent.

Note! In the interests of safety, spares requiring exposure to mains voltages can only be sent to competent persons.

Service

Our Service Force is available to provide a quality service at a reasonable cost. You will have the assurance of a Mira trained engineer/agent, genuine Mira spares, and a 12 month guarantee on the repair.

Payment should be made directly to the Service Engineer/Agent, using Visa, MasterCard or a cheque supported by a banker's card.

To Contact us

England, Scotland & Wales

Mira Showers Customer Services

Telephone: 0870 241 0888

8:30 am - 5:00 pm Working Days (4:30 pm Friday)

8:30 am - 12:30 pm Saturday

E-mail: technical@mirashowers.com

Fax: 01242 282595

By Post: Cromwell Road, Cheltenham
Gloucestershire, GL52 5EP

Northern Ireland

Wm H Leech & Son Ltd

Telephone: 028 9044 9257 - Mon to Fri 9:00 am - 5:00 pm

Fax: 028 9044 9234

Post: Maryland Industrial Estate
Ballygowan Road, Moneyreagh
Co Down, BT23 6BL

Republic of Ireland

Modern Plant Ltd (Dublin)

Telephone: 01 459 1344 - Mon to Fri 9:00 am - 5:00 pm

E-mail: sales@modernplant.ie

Fax: Dublin 01 459 2329

Post: Otter House, Naas Road
Clondalkin, Dublin 22

Modern Plant Ltd (Cork)

Telephone: 021 496 8755 - Mon to Fri 9:00 am - 5:00 pm

E-mail: cork@modernplant.ie

Fax: 021 496 8607

Post: Tramore Road, Cork

Mira Showers

Kohler Mira Ltd

Cromwell Road,

Cheltenham GL52 5EP.

Mira is a registered trade mark of
Kohler Mira Limited.

The company reserves the right to alter
product specifications without notice.

www.mirashowers.com



PM 14648

mira
SHOWERS