

# Calypso COK 611 Specifications

- 1 x 90mm Wastes with Basket Strainer Wastes. Capable of adaptation to take Waste Disposal Unit
- Bespoke accessories
- Unique Calypso Design

**N.B.** Ceramic sinks may vary +/- 1% due to the firing process.

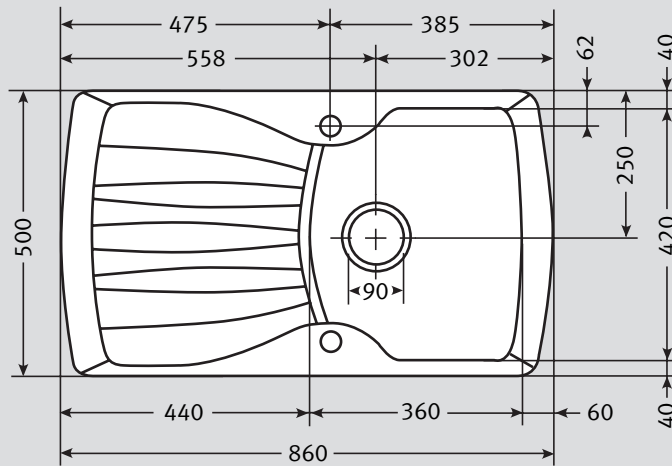

**Materials:** Fireclay Ceramic

**Application:** Inset

**Bowl Size:** 360 x 420 x 185

**Drainer Format:** Reversible

**Cut-out Size:** 790 x 470 (cr=20)

**Colour:** Gloss White or Eggshell Oatmeal

**Seal:** Utilise Mastic Sealant locally

**Insulation:** Integral

**Heat Resistance:** Up to 1000°C

**Earthing Point:** Not applicable

**Cabinet Size:**

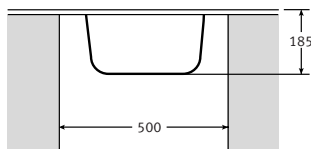

**Fixing Clips:** Utilise mastic

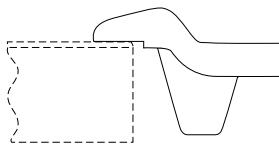

**Suggested Plumbing Kit:** 1 part

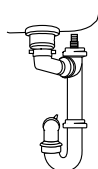

**Waste\*:** 1 x Lira 90mm Waste/Overflow

**Overflow\*:**

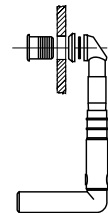
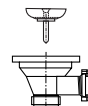

\*Also available in Zirconium finish

**Accessories Available:**

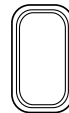

**Food Preparation Platter**  
Mahogany

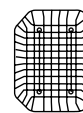

**Drainer Basket**  
Available in White

**Taps:** Any Franke tap can be utilised with this model\*.

\*Ceramic disc taps in certain installations or where there is a low head of water (below 4 metres) may not provide adequate flow rates. You are advised to check with your supplier.

**Guarantee:** Franke sinks are guaranteed for 25 years against manufacturing defect. Franke taps are guaranteed against defective materials and workmanship for 1 year in relation to coatings and finishes, and 5 years in relation to moving parts. Franke will replace (and where appropriate repair) defective sinks. In relation to taps, Franke will where appropriate provide replacement parts for your taps or replace your taps. Any associated or ancillary costs to be incurred by you as a result of replacement of Franke sinks and taps under this guarantee shall in all cases be previously approved by Franke UK Limited.

This guarantee is in addition to and does not affect your statutory rights.